



# PRODUCT SPECIFICATION GUIDE



## Low Maintenance and Barefoot Friendly

- EZ Dock polyethylene docks are durable and slip resistant
- Won't splinter or rot, never needs painting
- Cleans easily with soap and water



## Adaptable Design

- Unique design delivers outstanding load capacity, functionality, and safety
- Variety of dock sections, boat/PWC lifts, and launches for kayaks
- Easily customizable design to make your perfect waterfront retreat



## Flexible Flotation Technology

- Flotation chambers constructed for optimal strength and structural integrity. Concave pylon creates suction between the recess and the water
- Designed to provide additional stability on the water
- Dock sections adapt easily to changing water conditions and levels



## Innovative Coupling

- The Dog Bone, made of recycled materials
- Nuts and bolts made of heavy duty, rust resistant composite
- Strength and durability even in the harshest weather conditions



## American Made

- Proudly for 30 years

For questions about features, operation/performance, parts, accessories, or installation, call your local EZ Dock dealer.

# DOCK SECTIONS

EZ Dock's polyethylene dock sections offer unmatched performance when it comes to modular docking solutions. Our revolutionary design is durable, slip-resistant, and low maintenance to help ensure an enjoyable time on the water. Each dock and port section includes a decking surface and float structure in a single, integrated unit. Our proprietary flotation chamber and pylon design provides enhanced buoyancy and stability to reduce movement even in rough water and stormy conditions. Constructed with extra-heavy and extra-thick walls for optimal strength. No frame or expensive decking required.

- **100% virgin linear low-density polyethylene (LLDPE)**
- **UV Ray resistant**
- **Slip-resistant pattern**
- **Unique pylon (chamber) design grabs the water like an upside down cup**
- **Rotationally molded, to allow no seams or connection points**
- **62.5lbs. (28.3kg) per square foot, including dead load, standard**
- **30lbs. (13.6kg) per square foot, including dead load, low profile**

Part #	Model	Color	Dimensions (w x l x h)	Flotation	Notes
204060 204060-EZGR	Baby Dock Section	Beige Grey	39" x 58-1/2" x 14-5/8" 0.99m x 1.48m x 0.37m	1000 lbs. 453.6 kg	
204010 204010-EZGR	40" Dock Section	Beige Grey	39" x 117" x 14-5/8" 0.99m x 2.97m x 0.37m	2000 lbs. 907.1 kg	
206010 206010-EZGR	60" Dock Section	Beige Grey	58-1/2" x 117" x 14-5/8" 1.48m x 2.97m x 0.37m	3000 lbs. 1360.7kg	
208010 208010-EZGR	80" Dock Section	Beige Grey	78" x 117" x 14-5/8" 1.98m x 2.97m x 0.37m	4000 lbs. 1814.4 kg	
208008 208008-EZGR	100" Dock Section	Beige Grey	98" x 78" x 14-5/8" 2.49m x 1.98m x 0.37m	3100 lbs. 1406.1 kg	
158010 158010-EZGR	80" Low Profile Dock Section	Beige Grey	78" x 117" x 7-5/8" 1.98m x 2.97m x 0.19m	1900 lbs. 861.8 kg	
260120 260120-EZGR	Half Hex Dock Section	Beige Grey	58-1/2" x 59" x 117" x 14-5/8" 1.48m x 1.5m 2.97m x 0.37m	2000 lbs. 907.1 kg	
300503 300503-EZGR	Tri Section	Beige Grey	58-1/8" x 58-1/8" x 80-13/16" x 14-5/8" 1.48m x 1.48m x 2.05m x 0.37m	750 lbs. 340.2 kg	
301100 315100 <i>Low Pro</i>	"Dog Bone" Coupler Set w/ Hardware	Black		N/A	

# PERSONAL WATER CRAFT PORTS

EZ Ports feature a raised bow stop that helps prevent overshooting the port, with no winching, cranking, pumping, or hoisting needed. All EZ Ports can be linked together and easily adapted to other floating and fixed docks using our revolutionary Dog Bone coupler system with EZ Dock connectors. The same proprietary flotation chamber and pylon design provides enhanced buoyancy and stability. EZ Port also provides plenty of space on the front and either side of the port to allow PWC users to find their footing comfortably. EZ Port PWC lifts move with changing water levels, protecting personal watercraft from waves, wind, and the damage they can cause. Our personal watercraft ports are also covered by an industry-leading 8-year warranty. Low maintenance and barefoot friendly, EZ Dock's polyethylene ports are durable and slip resistant. They won't splinter or rot, and never need painting. They are easy to clean with a pressure washer or EPA-approved cleaning solutions.

Part #	Model	Color	Dimensions (w x l x h)	Flotation	Notes
206037PW 206037PW-EZGR	EZ Port VXP	Beige Grey	153" x 58-1/2" x 14-5/8" 3.88m x 1.48m x .37m	Rec. Lite + Rec.	
					
206040PW 206040PW-EZGR	EZ Port 260	Beige Grey	156" x 60" x 14-5/8" 3.96m x 1.52m x .37m	Most PWCs	
					
208013PW 208013PW-EZGR	EZ Port 280	Beige Grey	156" x 78" x 14-5/8" 3.96m x 1.98m x .37m	Most PWCs	
					
206036PW 206036PW-EZGR	EZ Port 2i	Beige Grey	168" x 58-1/2" x 14-5/8" 4.26m x 1.48m x .37m	Most PWCs	
					
206028BS-EZ 206028BS-EZ-EZGR	Bow Stop Kit for 2i	Beige Grey	33" x 10" x 16" .83m x .25m x .4m	N/A	
					

# EZ PORT MAX INLINE

The modular, adjustable, and expandable EZ Port MAX PWC port system is built to accommodate multiple PWCs of different shapes. The EZ Port MAX is one of the most flexible options available and can be customized to maximize slip spaces with tandem inlines that help you accommodate more PWCs per slip. Configure the design that best suits your waterfront and adjust it whenever your needs change.

Part #	Description	Color	Size	Flotation	Notes
206033EX-EZ 206033EX-EZGR 	EZ Port MAX Easy-Lift Entry	Beige Grey	43-1/2" x 58-1/2" x 10-7/16" 1m x 1.5m x 25cm	N/A	
206030PW-EZ 206030PW-EZGR 	EZ Port MAX Entry	Beige Grey	149" x 58-1/2" x 10-7/16" 4m x 1.5m x 25cm	Most PWCs	
206031PW-EZ 206031PW-EZGR 	EZ Port MAX Extension	Beige Grey	146" x 58-1/2" x 10-7/16" 3.7m x 1.5m x 25cm	Most PWCs	
206025BS-EZ 206025BS-EZGR 	EZ Port MAX Full Deck Bow	Beige Grey	39" x 58-1/2" x 10-1/2" 99cm x 1.5m x 25cm	N/A	
206027BS-EZ 206027BS-EZGR 	EZ Port MAX Small Bow	Beige Grey	38-1/2" x 20-13/16" x 15" 97cm x 51cm x 38cm	N/A	

Combined multiple parts of the EZ Port MAX Inline to accommodate multiple ports.

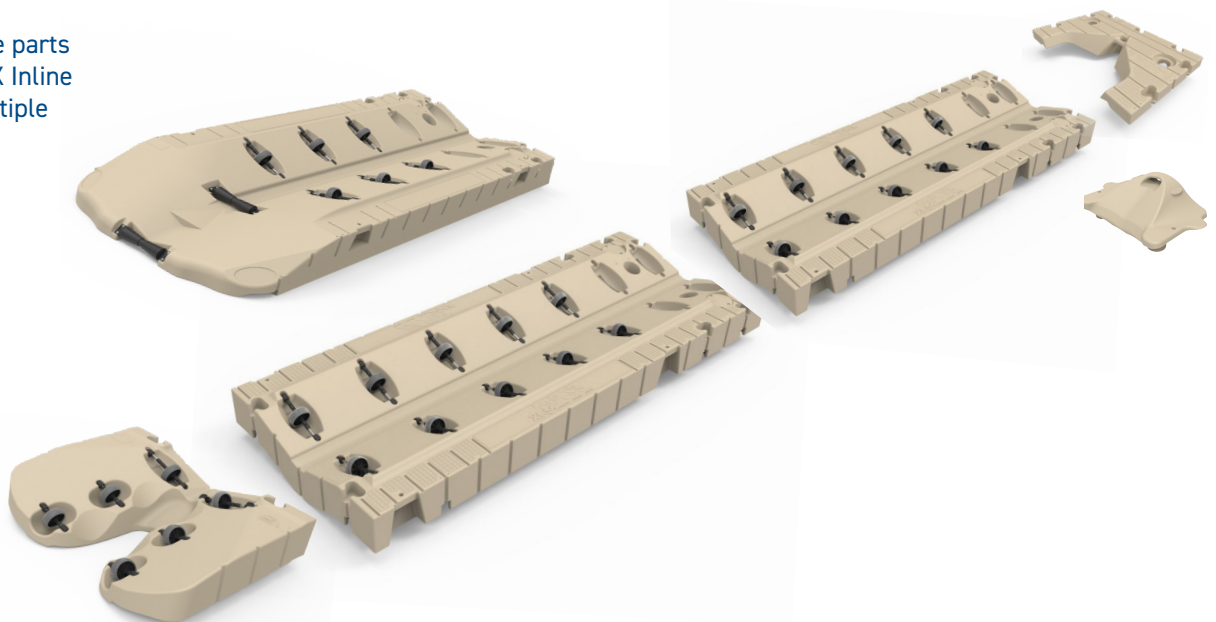

# EZ LAUNCH<sup>®</sup> RESIDENTIAL

- Dock entry enables stable, dry entry.
- Launch-assist paddle notches support easy entry/exit. V-shaped entry centers vessel for a confident, consistent launch. (patented US 10,793,237 B2)
- Engineered to connect with virtually any dock (EZ Dock or any other dock).
- Fits canoes, tandem kayaks, stand-up paddleboards, etc.

Part #	Description	Color	Size	Flotation	Notes
200900 200900-EZGR	 EZ Launch for Kayaks	Beige Grey	168" x 58" x 24" 4.26m x 1.47m x 61cm	750 lbs. 340kg	
200683	 EZ Launch Extension RAIL	Aluminum	5 lbs. 2.2kg	N/A	
208112	 EZ Launch Slide Bunk Kit	Blue	5 lbs. 2.2kg	N/A	

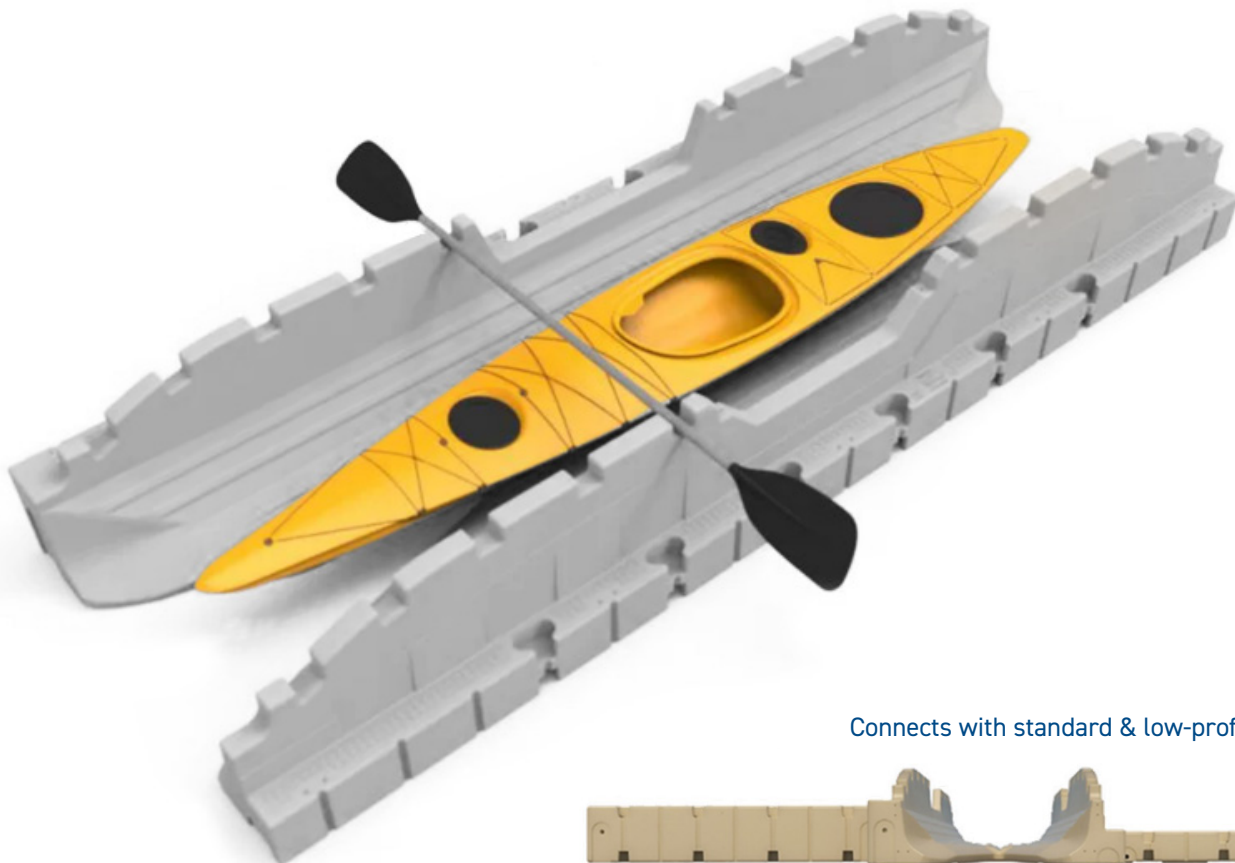

Connects with standard & low-profile dock sections

# EZ LAUNCH® COMMERCIAL

A first in the industry, the EZ Launch® Accessible Transfer System for kayaks and canoes provides individuals with disabilities accessibility that exceeds the minimum requirements of the Americans with Disabilities Act (ADA). The easy-to-use transfer bench and transfer slide boards allow users to simply sit, slide over, and drop down into a kayak or canoe, then use the side rails to pull off or back on.

Part #	Description	Color	Size	Notes
5008900 	EZ Launch Transfer System	Beige Grey	350 lbs. 159kg	
100757SS 	EZ Launch Adjustable Adapter Kit	Stainless Steel	23 lbs. 10kg	
500901 500901-EZGR 	EZ Launch Extension Railing	Beige Grey  Aluminum	126 lbs. 57kg	
500900L 	EZ Launch Entry Railing Left	Aluminum	126 lbs. 57kg	
500900R 	EZ Launch Entry Railing Right	Aluminum	126 lbs. 57kg	
35116 35118 	Security Curbing	Brown Black	118" x 3-1/2" x 2-1/2" 3m x .08m x .06m  118" x 5-3/4" x 2" 3m x .14m x .05m  31 lbs. (14kg)	
S50911 	PVC Sleeved Roller - Kit of 5			

**EZ Launch® Drive Thru with Transfer Bench & Small Platform**

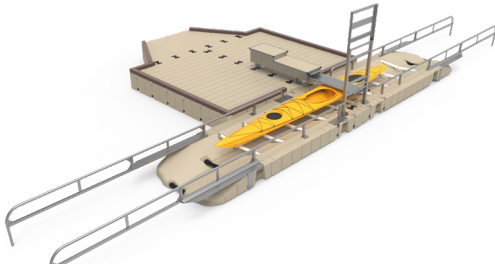

**EZ Launch® Drive Thru with Large Platform**

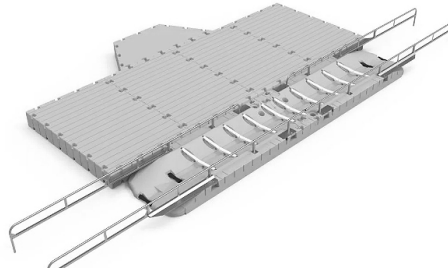

**EZ Launch® One-Way with Small Platform & Tri Dock**

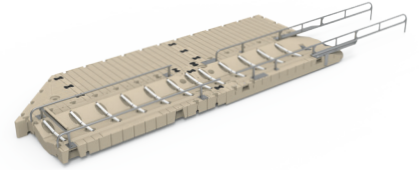

**EZ Launch® One-way with Large Platform & Boat Slip**

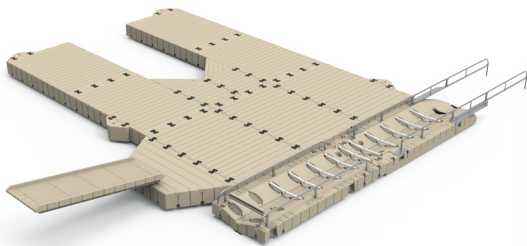

**EZ Launch® One-way & Extra-Large Platform**

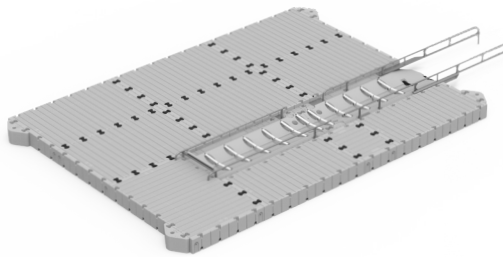

**EZ Launch® Drive Thru with Small Platform**

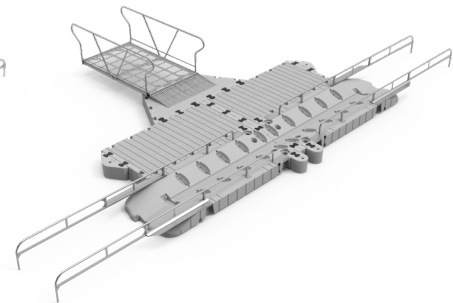

**EZ Launch® One-Way with Transfer Bench, Handrail, & Large Platform**

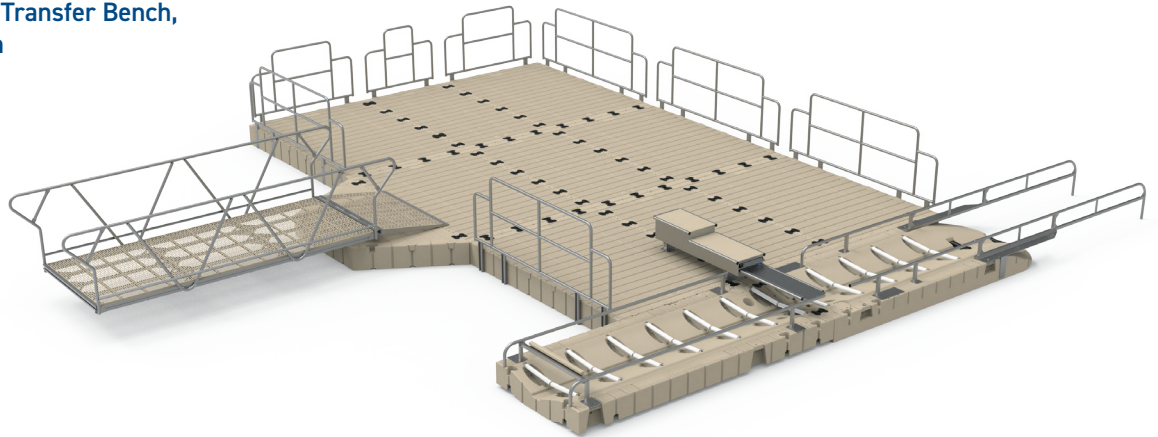

**EZ Launch® Multiple One-way with Transfer Bench**

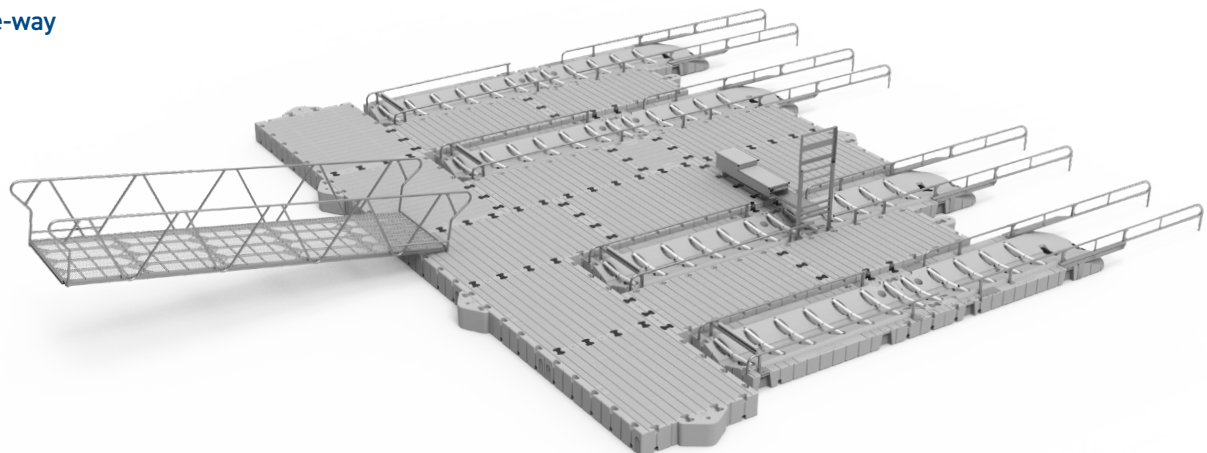

# OPTIMUS BOATPORT®

## Features and Benefits:

### • Easy Boat Access and Maintenance

With our Optimus Boat Port, maintaining your boat becomes hassle-free. Enjoy effortless access for regular maintenance, cleaning, and inspections, ensuring your vessel stays in top-notch condition.

### • Reduce Anti-foul Paint Application

The Optimus Boat Port significantly decreases the need for frequent anti-foul paint re-application; extending your boat's lifespan and preserving its value and saving you time and money in the long run.

### • Versatile Boat Compatibility

Our boat port is designed to accommodate various boats up to 7,000lbs (3175kg) in wet weight and ranging from 16' (4.87m) to 24' (7.31m) in length, ensuring a perfect fit for your watercraft.

### • Effortless Entry and Exit

Enjoy a simple and easy low-angle entry and exit with our Boat Port EZ Dock, making boating experiences smoother and more enjoyable.



Part #	Description	Color	Size	Notes
BP208120ENT BP208120ENT-EZGR 	Entry Section Kit - Entry Section 208120ENT(-EZGR) - Entry Inlay S20819 - BPKIT1 - 3x BPKIT2 - 4x Adjustable Rails S20815K - 2x Bunk Housings S20816K - 10x BPKIT3		117" x 93" x 15" 297cm x 236cm x 38cm	
208120ENT 208120ENT-EZGR 	Entry Section	Beige Grey	117" x 93" x 15" 297cm x 236cm x 38cm	
S20819K 	Entry Inlay	Dark Grey	50" x 19.5" x 15.5" 127cm x 49.5cm x 39cm 29lbs. (13 kg)	
BPKIT1 	3 Piece Roller, Entry Kit	Blue & Dark Grey	10lbs. 7 kg	
BPKIT2 	3 Piece Roller for Base	Blue & Dark Grey	8.5lbs. 13.8 kg	
S20815K 	Adjustable Rail	Alum	29.75" x 2.5" x 1" 75.5cm x 6.3cm x 2.5cm 2lbs. (.9 kg)	
S20816K S20816K-EZGR 	Bunk Housing	Beige Grey	76" x 12" x 7.75" 193cm x 30.5cm x 19.7cm 28lbs. (12.7 kg)	
BPKIT3 	6" Bunk Assembly (15.24cm)	Dark Grey	3.5lbs. 1.6 kg	
BP208120EXT BP208120EXT-EZGR 	Extension Section Kit - Extension Section 208120EXT - 2x BPKIT2 (see above) - 4x Bunk Rail Fill-in S20828K - 4x Top Connectors S20817 - 4x Bottom Connectors S20818K		117" x 93" x 15" 297cm x 236cm x 38cm	
208120EXT 208120EXT-EZGR 	Extension Section	Beige Grey	117" x 93" x 15" 297cm x 236cm x 38cm	
S20828K 	Bunk Rail Fill-in	Dark Grey	29.75" x 2.5" x .75" 75.5cm x 6.3cm x 1.9cm	
S20817 S20817-EZGR 	Top Connector	Beige Grey	24" x 9" x 7" 61cm x 23cm x 18cm 8lbs. (3.6 kg)	
S20818K S20818K-EZGR 	Bottom Connector	Beige Grey	24" x 9" x 7" 61cm x 23cm x 18cm 8lbs. (3.6 kg)	

Part #	Description	Color	Size	Notes
BPKIT1	 <p>3 Piece Roller, Entry Kit                      - Bell Roller S28824                      - Center Keel Roller Entry S28823                      - Keel Shaft Clip S20821                      - Entry Roller Shaft S28822                      - 2x 5/16" X 1" bolt 80510SS</p>	Blue & Dark Grey	10lbs. 7 kg	
S28824	 <p>Bell Roller</p>	Blue & Dark Grey	2.5lbs. 1.1 kg	
S28823	 <p>Center Keel Roller Entry</p>	Blue & Dark Grey	2lbs. .9 kg	
S20821	 <p>Keel Shaft Clip</p>	Dark Grey	0.25lbs. 1.1 kg	
S28822	 <p>Entry Roller Shaft</p>	SS	2.5lbs. .1 kg	
BPKIT2	 <p>3 Piece Roller for Base                      - Bell Roller S28824 (see above)                      - Center Keel Roller S28826                      - Keel Shaft Clip S20821 (see above)                      - Entry Roller Shaft S28827                      - 2x 5/16" X 1" bolt 80510SS</p>	Blue & Dark Grey	8.5lbs. 13.8 kg	
S28826	 <p>Center Keel Roller</p>	Blue & Dark Grey	1.5lbs. .7 kg	
S28827	 <p>Shaft for Keel Roller</p>	SS	2lbs. .9 kg	
BPKIT3	 <p>6" (15.24cm) Bunk Assembly                      - Bunk Roller S28829                      - Bunk Shaft Retainer S28832                      - Shaft for Bunk roller S28831                      - 5/16" X 1" bolt 80510SS</p>	Dark Grey	3.5lbs. 1.6 kg	
S28829	 <p>Bunk Roller</p>	Dark Grey	2.25lbs. 1 kg	
S28832	 <p>Bunk Shaft Retainer</p>	Dark Grey	0.25lbs. 1.1 kg	
S28831	 <p>Shaft for Bunk Roller</p>	SS	1lbs. .45 kg	

Part #	Description	Color	Dimensions	Notes
S20825 S20825-EZGR	 3 1/2" (9cm) Pipe Bracket	Beige Grey	14" x 9" x 15" 35.5cm x 23cm x 38cm 7.25lbs. 3.3 kg	
100758	 Optimus to EZ Dock connector Hinge Allows Optimus BoatPort connection to EZ Dock sections.	Galv.	9.5" x 15" x 36" 24.1cm x 38.1cm x 91.4cm 23lbs. 10.4kg	
100759	 Optimus to Traditional Dock connector Hinge Allows Optimus BoatPort connection to Standard sections.	Galv.	9.5" x 15" x 36" 24.1cm x 38.1cm x 91.4cm 20lbs. 9 kg	
S20826 S20826-EZGR	 Pocket Filler	Beige Grey	14" x 9" x 7.5" 35.5cm x 23cm x 19cm 7.25lbs. 3.3 kg	
S20820 S20820-EZGR	 Keel Rest	Beige Grey	23" x 22.5" x 9.25" 58.4cm x 57cm x 23.5cm 20.75lbs. 9.4 kg	
208121 208121-EZGR	 6' (1.83m) Boatport Walkway <i>* Does not include hardware connectors</i>	Beige Grey	74" x 12" x 15" 183cm x 30.5cm x 38cm 37lbs. 16.8 kg	
208123 208123-EZGR	 8' (2.43m) Boatport Walkway <i>* Does not include hardware connectors</i>	Beige Grey	91" x 12" x 15" 243.8cm x 30.5cm x 38cm 47lbs. 21.3 kg	
S20832	 Base Position for Winch Stand <i>* Does not include hardware</i>	Galv.	36" x 23" x 6.5" 91.4cm x 58.4cm x 16.5cm 118lbs. 53.5 kg	
S20833	 Winch Stand Assembly - 3200 lbs.	Galv.	32" x 32" x 12" 81.3cm x 81.3cm x 30.5cm 64.5lbs. 29.2 kg	

# OPTIMUS BOATPORT® CUSTOMIZED OPTIONS

## 16'

- V hull type boats up to 5,500 lbs. (2,495 kg) in wet weight
- Up to 16 feet (4.16m) in length

### Configuration includes:

- 1- Entry Section Kit (BP208120ENT)
- 1- Extension Section Kit (BP208120EXT)
- Available in Grey and Beige



## 16'

### with Side Extensions

- V hull type boats up to 5,500 lbs. (2,495 kg) in wet weight
- Up to 16 feet (4.16m) in length

### Configuration includes:

- 1- Entry Section Kit (BP208120ENT)
- 1- Extension Section Kit (BP208120EXT)
- 2- 6' (1.83m) BoatPort Walkways (208121)
- 2- 8' (2.43m) BoatPort Walkways (208123)
- Available in Grey and Beige



## 24'

- V hull type boats up to 7,000 lbs. (3,175 kg) in wet weight
- 16 to 24 feet (4.16m to 7.3m) in length

### Configuration includes:

- 1- Entry Section Kit (BP208120ENT)
- 2- Extension Section Kit (BP208120EXT)
- Available in Grey and Beige

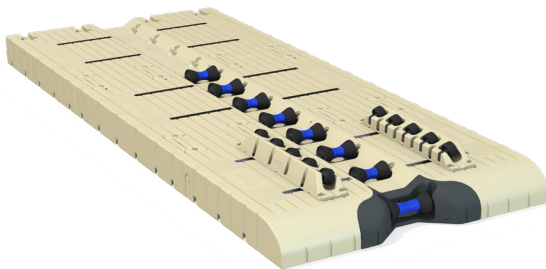

## 24'

### with Side Extensions

- V hull type boats up to 7,000 lbs. (3,175 kg) in wet weight
- 16 to 24 feet (4.16m to 7.3m) in length

### Configuration includes:

- 1- Entry Section Kit (BP208120ENT)
- 2- Extension Section Kit (BP208120EXT)
- 2- 6' (1.83m) BoatPort Walkways (208121)
- 4- 8' (2.43m) BoatPort Walkways (208123)
- Available in Grey and Beige

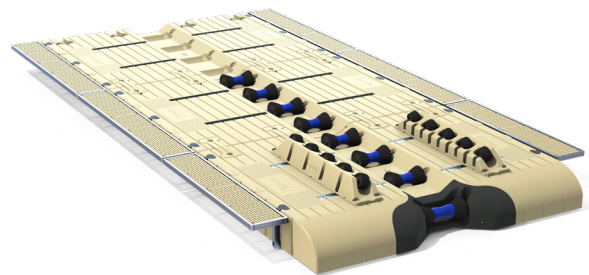

## 32'

- V hull type boats up to 9,000 lbs. (4,082 kg) in wet weight
- 24 to 32 feet (7.3m to 9.75m) in length

### Configuration includes:

- 1- Entry Section Kit (BP208120ENT)
- 3- Extension Section Kit (BP208120EXT)
- Available in Grey and Beige

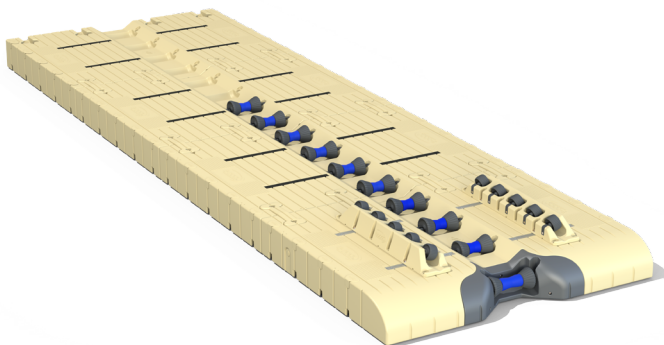

## 32'

### with Side Extensions



- V hull type boats up to 9,000 lbs. (4,082 kg) in wet weight
- 24 to 32 feet (7.3m to 9.75m) in length

### Configuration includes:

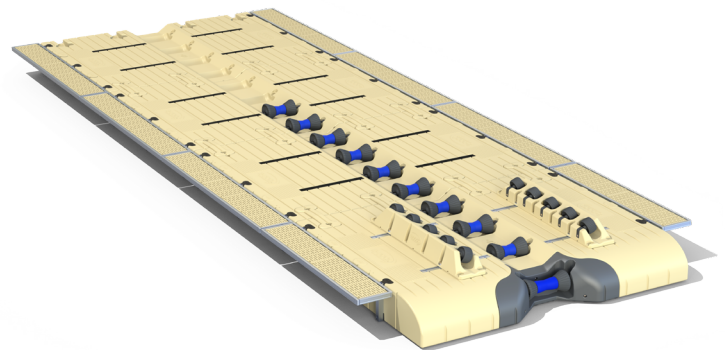
- 1- Entry Section Kit (BP208120ENT)
- 3- Extension Section Kit (BP208120EXT)
- 2- 6' (1.83m) BoatPort Walkways (208121)
- 6- 8' (2.43m) BoatPort Walkways (208123)
- Available in Grey and Beige

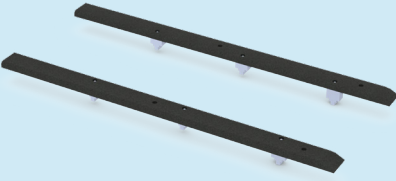

# OPTIMUS BOATPORT® STEPPED HULL

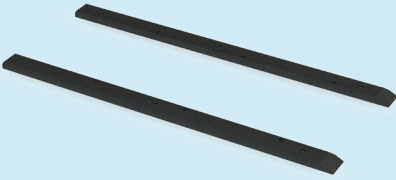
Part #	Description	Color	Size	Notes
S20827K	 Stepped Hull Bunk Kit- 22' boats & smaller - 1x Left, 1x Right Recycled Plastic Lumber Stepped Hull Bunk S20827L/S20827R - 2x Large Stepped Hull Block S20841 - 4x Small Stepped Hull Block S20842 - 6x Flat Washers 5/16" 18-8 SS 117003 - 6x Lock Washers 5/16" 18-8 SS 117004 - 4x Hex Bolts 5"x5/16 18 SS 10259SS - 2x Hex Bolts 6"x5/16 18 SS 10257SS	Dark Grey	84" x 5.5" x 1.5" 213cm x 14cm x 3.8cm	
S20827L S20827R	Recycled Plastic Lumber Stepped Hull Bunk - Left and Right	Drk Grey	22.5lbs. 10.2 kg	
S20841	 Large Stepped Hull Block	Alum.		
S20842	 Small Stepped Hull Block	Alum.		
S20827K24	 Stepped Hull Bunk Kit - 24' boats & larger - 1x Left, 1x Right Recycled Plastic Lumber Stepped Hull Bunk S20827L/S20827R - 6x Flat Washers 5/16" 18-8 SS 117003 - 6x Lock Washers 5/16" 18-8 SS 117004 - 2x Hex Bolts 2.5"x5/16 18 SS	Dark Grey	84" x 5.5" x 1.5" 213cm x 14cm x 3.8cm	

## 24' Stepped Hull

- Stepped hull type boats up to 7,000 lbs. (3,175 kg) in wet weight
- Up to 22 feet (6.7m) in length

### Configuration includes:

- 1- Entry Section Kit (BP208120ENT)
  - 2- Extension Section Kit (BP208120EXT)
  - 1- Stepped Hull Bunk Kit (S20827K-BP)
- Available in Grey and Beige

## 24' Stepped Hull with Side Extensions

- Stepped hull type boats up to 7,000 lbs. (3,175 kg) in wet weight
- 24 feet (7.3m) in length and larger

### Configuration includes:

- 1- Entry Section Kit (BP208120ENT)
  - 2- Extension Section Kit (BP208120EXT)
  - 1- Stepped Hull Bunk Kit (S20827K24-BP)
  - 2- 6' (1.83m) BoatPort Walkways (208121)
  - 4- 8' (2.43m) BoatPort Walkways (208123)
- Available in Grey and Beige

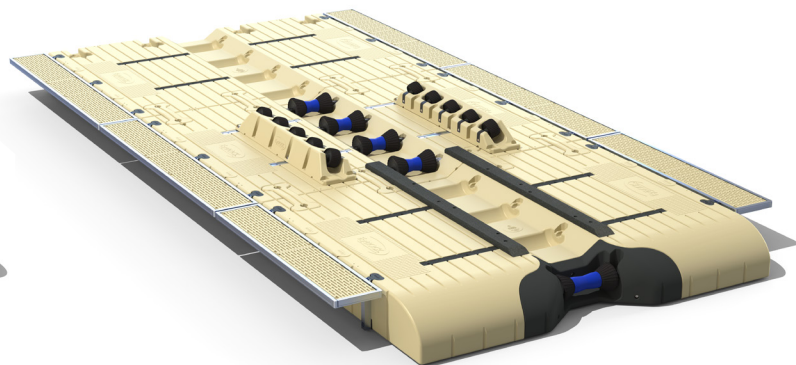
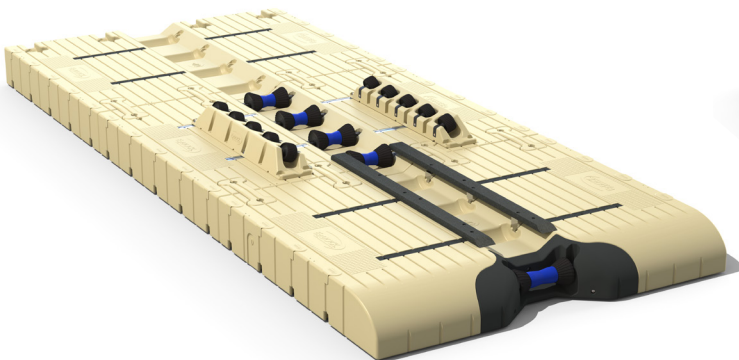

# EZ BOATPORT®

The EZ BoatPort is a simple and stable drive-on, drive-off method of docking for boats in a wide range of sizes up to 5,000 lbs.

- Configurations to fit multiple boat shapes and sizes
- Works with existing floating or fixed docks
- Can be used in as little as 2ft of water without float tanks
- No winching, cranking, or hoisting
- Two skid bunk options to fit a variety of hull shapes and sizes
- Up to three additional keel rollers for longer boats
- Optional supplemental flotation kit for added buoyancy
- Optional side extensions for additional walk-around room

Part #	Description	Color	Size	Flotation	Notes
208015BL 208015BL-EZGR 	EZ BoatPort	Beige Grey	164" x 78" x 14-5/8" 4.16m x 1.98m x 37cm	2000 lbs. 907.18kg	
208015EX 208015EX-EZGR 	EZ BoatPort Side Extension	Beige Grey	164" x 20" x 14-5/8" 4.16m x 50.8cm x 37cm	500 lbs. 227kg	
208104 208104-EZGR 	EZ BoatPort H Connector	Beige Grey	13.5" x 7.5" x 12" 34.29cm x 19cm x 30.48cm  15 lbs. 7kg	N/A	
208105 208105-EZGR 	EZ BoatPort T Connector	Beige Grey	13.5" x 7.5" x 12" 34.29cm x 19cm x 30.48cm  7 lbs. 3kg	N/A	
208109 	EZ BoatPort Sail Bunk	Dark Grey	108" x 8" x 10" 2.74m x 48.26cm x 25.4cm  35 lbs. 16kg	N/A	
208101 	EZ BoatPort Long Bunk	Dark Grey	108" x 8" x 10" 2.74m x 48.26cm x 25.4cm  35 lbs. 16kg	N/A	
208102 	EZ BoatPort Short Bunk	Dark Grey	75" x 8" x 5" 1.9m x 48.26cm x 12.7cm  33 lbs. 15kg	N/A	

# EZ BOATPORT® CUSTOMIZED SOLUTIONS

Part #	Description	Color	Size	Flotation	Notes
BP2000 BP2000-EZGR	EZ BoatPort	Beige Grey	164" x 78" x 14-5/8" 4.16m x 1.98m x 37cm	2000 lbs. 907.18kg	
	Long Bunks 208101				
	Short Bunks 208102				
	Sail Bunks 208109				
BP3000 BP3000-EZGR	EZ BoatPort with Side Extensions	Beige Grey	117" x 164" x 14-5/8" 2.97m x 4.16m x 37.14cm	3000 lbs. 1360.7kg	
	Long Bunks 208101		140 sf 13m <sup>2</sup>		
	Short Bunks 208102				
BP3001 BP3001-EZGR	EZ BoatPort with Side Extensions & Large Platform	Beige Grey	117" x 222" x 14-5/8" 2.97m x 5.63m x 37.14cm	3000 lbs. 1360.7kg	
			190 sf 18m <sup>2</sup>		
					

# AEGIS BOAT LIFT

The Aegis boat lift promotes fast and convenient access to your boat and keeps it looking like new.

- Flotation capacity of up to 7,000 lbs. (3175kg) in weight and 28 feet (8.53m) in length.
- Fully adjustable polyethylene bunks configure to your boat, with the ability to customize as needed.
- Fits a variety of hull configurations including V-Hull, stepped hull, pontoon, tritoon, wake boats, and catamarans.
- A 110v air assist pump available with either a single or dual valve unit.
- Lift is compatible with EZ Dock products and traditional dock systems.
- Precision-molded, Linear Low-Density Polyethylene (LLDPE) lift tanks.
- Resistant to the worst weather conditions, and low water damage.
- Keeps the boat out of the water and free from marine growth on outdrives and the hull of your boat.
- Hot-dipped, galvanized steel and corrosion-resistant frame and hardware.
- Features premium low-friction and high strength, ultra-high molecular weight (UHMW), polyethylene bearing surfaces.

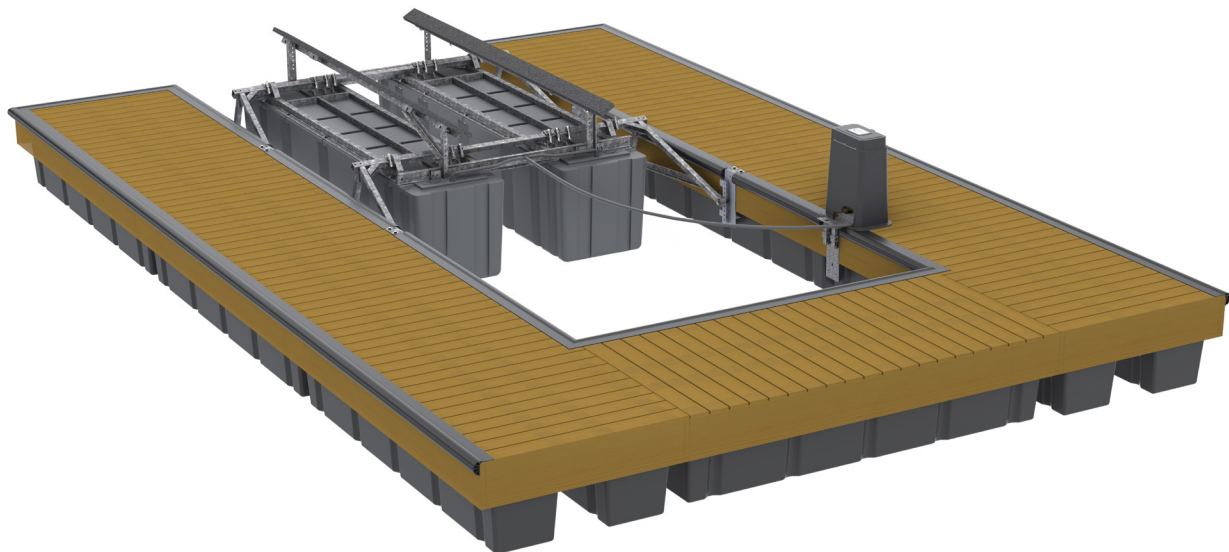
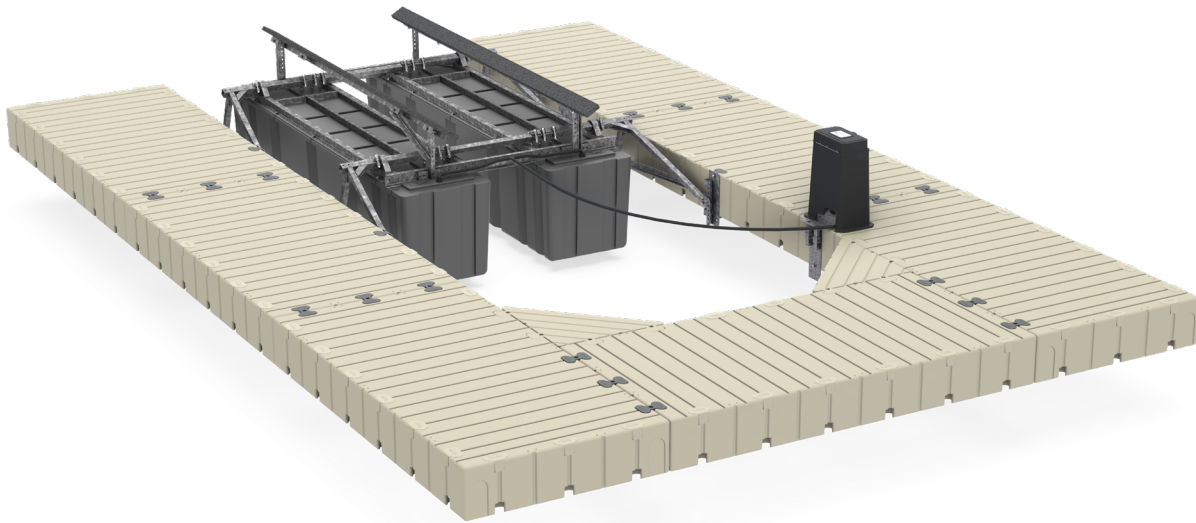

## STEP 1 CHOOSE A FRAME OPTION THAT FITS YOUR NEEDS

- Both 4' and 5' arms are used for all dock types.
- 5' arms are useful to fine tune the distance of the bow of the boat to the front of the slip with EZ Dock coupler pockets.
- Arm length does not affect the boat height out of water.

Part #	Description	Notes
AG7000	4' (1.2m) BoatLift Frame Kit 4' (1.2m) Arm, Pitmans down to include the universal dock connector	
AG7001	4' (1.2m) BoatLift Frame Kit 4' (1.2m) Arm, Pitmans up to include the universal dock connector	
AG7002	5' (1.5m) BoatLift Frame Kit 5' (1.5m) Arm, Pitmans down to include the universal dock connector	
AG7003	5' (1.5m) BoatLift Frame Kit 5' (1.5m) Arm, Pitmans up to include the universal dock connector	

Pitman Arms are the shafts that translates rotary or angular movement into linear movement, or vice versa. Pitmans up vs. pitmans down has everything to do with the beam, overall width, of the particular watercraft you are lifting and where the beam is located on that watercraft.

### Pitman Arms Down

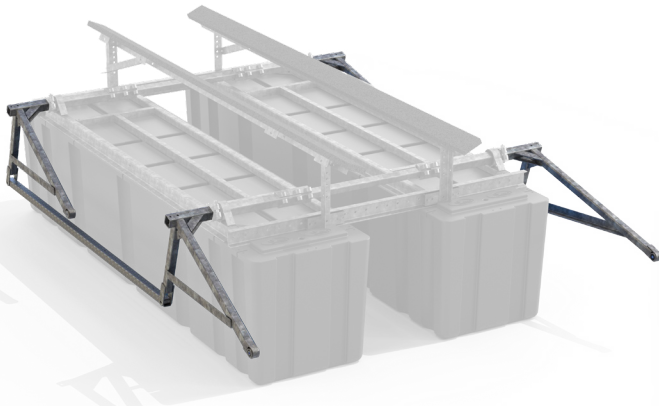

- For use with Pontoon and Tritoon Boats with a beam of 8' 6" (2.64m) or more.\*
- Recommended for Deck Boats.
- Only width restriction is the distance between the dock brackets which are attached to the dock.

### Pitman Arms Up

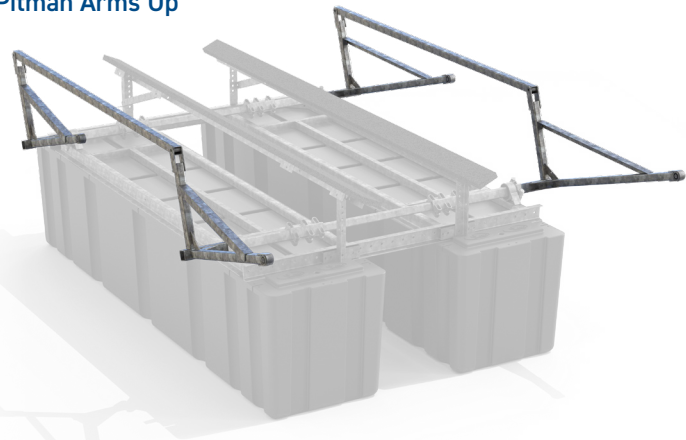

- Arms act as a step to access the boat.
- Keeps steel out of water.
- Fit most, V-Hull boats, with a beam of 8' 6" (2.64m) or less.\*

## STEP 2 CHOOSE THE SLIP THAT THE FRAME WILL FIT INTO

Part #	Description	Notes
AG-KIT-10	10' (3m) Slip & Standard 10' (3m) Frame to Frame Floating boat slip	
AG-KIT-11	11' (3.3m) Slip & Standard 10' (3m) Frame to Frame Floating boat slip	
AG-KIT-12	12' (3.65m) Slip & Standard 10' (3m) Frame to Frame Floating boat slip	

\*for use in a 10' (3m) slip

# AEGIS BOAT LIFT

## STEP 3 CHOOSE YOUR BOATS HULL SHAPE

- 12' pads will work the majority of the time across all boat types
- 14' pads are useful primarily for Pontoon & Tritoon boats over 24' to support the weight.
- 14' pads are also useful for inboard wake boats to get the bunks further back on the boat.

Part #	Description	Size	Notes
AGI12	Inboard/Wake Bunk Kit, 12' (3.65m) Pads		
AGI14	Inboard/Wake Bunk Kit, 14' (4.26m) Pads		
AGP12D	Pontoon Bunk Kit, 12' (3.65m) Pads, Pitmans down		
AGP12U	Pontoon Bunk Kit, 12' (3.65m) Pads, Pitmans up		
AGP14D	Pontoon Bunk Kit, 14' (4.26m) Pads, Pitmans down		
AGP14U	Pontoon Bunk Kit, 14' (4.26m) Pads, Pitmans up		
AGT12D	Tritoon Bunk Kit, 12' (3.65m) Pads, Pitmans down		
AGT12U	Tritoon Bunk Kit, 12' (3.65m) Pads, Pitmans up		
AGT14D	Tritoon Bunk Kit, 14' (4.26m) Pads, Pitmans down		
AGT14U	Tritoon Bunk Kit, 14' (4.26m) Pads, Pitmans up		
AGV12U	V Hull Bunk Kit 12' (3.65m) Pads		
AGV14U	V Hull Bunk Kit 14' (4.26m) Pads		

## STEP 4 CHOOSE YOUR CONTROL UNIT

Part #	Description	Size	Notes
700010	110 Volt Single Valve Unit with Cover & Mounting Plate		
700020	110 Volt Dual Valve Unit with Cover & Mounting Plate		

## STEP 5 FLOTATION TANKS

Part #	Description	Size	Notes
BL0007K2	2 Flotation Tanks		

THE COMPLETE AEGIS SET UP BELOW SHOW

**STEP 1** 4' (1.2 meter) Pitman Arms Down, part # AG7000

**STEP 2** 10' (3 meter) Slip Width, AG-KIT-10

**STEP 3** V-Hull Bunk Kit with 12' (3.6 meter) Pads, part # AGV12U

**STEP 4** Standard 110v Pump, part # 700010

**STEP 5** Flotation Tanks, part # BL000K2

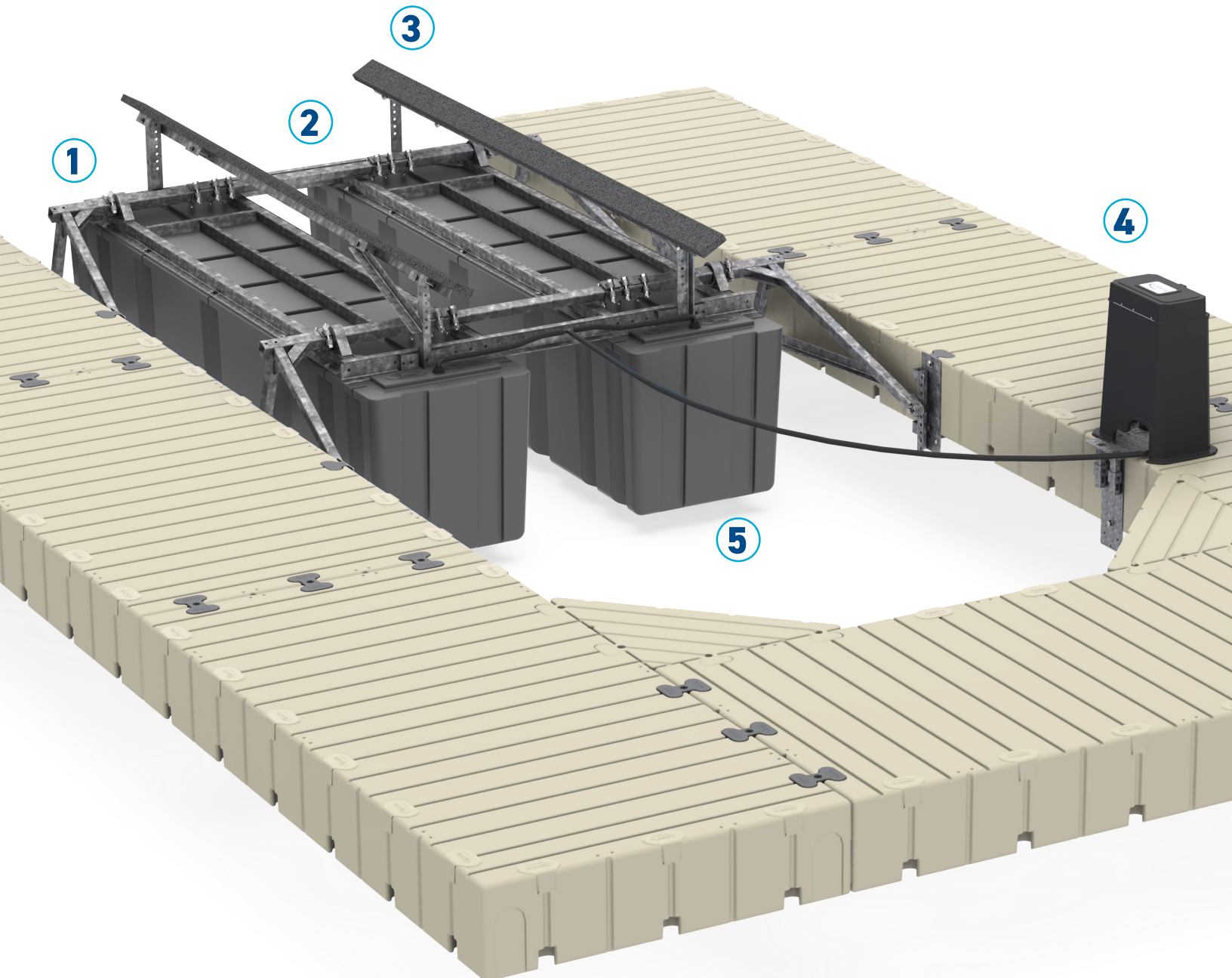

# ANCHORING

Part #	Description	Color	Size	Notes
135250 135250-EZGR	 Standard 2.5" (6.35cm) Pipe Bracket Standard-duty polyethylene bracket provides ample anchoring for ports and smaller docks.	Beige Grey	For 2.375" (6cm) O.D. pipe  21lbs. 9.55kg	
135350 135350-EZGR	 Standard 3.5" (9cm) Pipe Bracket Standard-duty polyethylene bracket provides ample anchoring for ports and smaller docks.	Beige Grey	For 3.5" (9cm) O.D. pipe  21lbs. 9.55kg	
138250 138250-EZGR	 Standard 2.5" (6.35cm) Pipe Bracket Standard-duty polyethylene bracket provides ample anchoring for ports and smaller, low profile, docks.	Beige Grey	For 2.375" (6cm) O.D. pipe  13lbs. 5.9kg	
138350 138350-EZGR	 Low Profile 3.5" (9cm) Pipe Bracket Standard-duty polyethylene bracket provides ample anchoring for ports and smaller, low profile, docks.	Beige Grey	For 3.5" (9cm) O.D. pipe  13lbs. 5.9kg	
130250 130250-EZGR	 Standard 2.5" (6.35cm) Pipe Bracket Standard-duty polyethylene bracket provides ample anchoring for ports and smaller docks.	Beige Grey	For 2.375" (6cm) O.D. pipe  14lbs. 6.35kg	
130350 130350-EZGR	 Standard 3.5" (9cm) Pipe Bracket Standard-duty polyethylene bracket provides ample anchoring for ports and smaller docks.	Beige Grey	For 3.5" (9cm) O.D. pipe  14lbs. 6.35kg	

Part #	Description	Color	Size	Notes
215250 215250-EZGR 	Standard 2.5" (6.35cm) Pipe Bracket Heavy-duty polyethylene pipe bracket allows docks to adjust to changing water levels.	Beige Grey	For 2.375" (6cm) O.D. pipe	
215350 215350-EZGR 	Heavy-Duty 3.5" (9cm) Pipe Bracket Heavy-duty polyethylene pipe bracket allows docks to adjust to changing water levels.	Beige Grey	For 3.5" (9cm) O.D. pipe	
100725P 	Deadweight insert for #215350 assembly	PVC coated	For 3.5" (9cm) O.D. pipe  15lbs. 6.8kg	
1051000 	Poly Pipe Stand-Off Bracket Attaches top of pipe to stationary docks.	Yellow	2.5" (6cm) to 3.5" (9cm) O.D. Pipe	
210250 210250-EZGR  10003(-BK) Replacement Insert	Standard 2.5" (6.35cm) Pipe Bracket w/Insert Heavy-duty polyethylene pipe bracket allows docks to adjust to changing water levels.	Beige Grey  Brown Black	For 2.375" (6cm) O.D. pipe	
210350 210350-EZGR  10004(-BK) Replacement Insert	Heavy-Duty 3.5" (9cm) Pipe Bracket w/Insert Heavy-duty polyethylene pipe bracket allows docks to adjust to changing water levels.	Beige Grey  Brown Black	For 3.5" (9cm) O.D. pipe	
300810 300810-EZGR 	Adjustable Piling Bracket Heavy-duty one-piece bracket allows lateral position adjustment to attach to piles from 6"-18" (15-46cm) in diameter. Bracket comes with two pairs of couplers with composite hardware.	Beige Grey	75" x 8" x 5" 1.91m x 20cm x 13cm	

# ANCHORING

Part #	Description	Color	Notes
100700SS 100700	 <p>Stiff-Arm, Mainframe Deadweight Bracket</p> <p>Includes hardware. Order stiff-arm insert, post sleeve, and anchoring pipe separately.</p>	Stainless Steel Galvanized	
800095-15 800095-20 800095-55	 <p>2" (5cm) Inner Dimension 2-1/2" (6.35cm) Inner Dimension 3-1/2" (8.89cm) Inner Dimension</p> <p>I.D. post sleeve for stiff arm</p>	Galvanized	
800099 S80094GV	 <p>Stiff-Arm Heavy-Duty Bracket</p> <p>Anchor to a shoreline abutment or shoreline post. Light-duty also available.</p> <p>Frame &amp; Yoke (shown). Sea wall attachment bracket (not shown).</p>	Stainless Steel Galvanized	
100800	 <p>Piling Bracket</p> <p>Predrilled for hoops (sold separately) and includes nuts and connectors. SS hardware available. To be used in conjunction with the hoops below.</p>	Galvanized	
100804 100808 100812 100816 100820	 <p>Hoops for Piling Bracket</p> <p>4" (10cm) 8" (20cm) 12" (30cm) 16" (41cm) 20" (51cm)</p>	Galvanized	



Part #	Description	Color	Notes
100740 100740SS 	Deadweight Bracket Kit  For light-duty anchoring with chain and/or to attach 4" (10cm) x 4" (10cm) railing or mooring posts. Sold in pairs. Chain sold separately.	Stainless Steel Galvanized	
100730 	Deadweight Winch insert  Deadweight insert and cable winch added to our polyethylene pipe bracket allows easy dock adjustment for water fluctuations. Cable sold separately.	Galvanized	
100750 100750SS 	Adapter Hinge  Reversible hinge allows EZ Dock sections to be attached to other floating docks.	Stainless Steel Galvanized	
100751 100751SS 	EZ Port Adapter Hinge  Reversible hinge allows EZ Ports to be attached to other floating docks.	Stainless Steel Galvanized	
100255 For 2.375" (6cm) O.D. pipe  100355 For 3.5" (9cm) O.D. pipe 	Pipe Auger  Auger with bolt and nut allows for drilling and setting pipe in lake, river, or ocean bottoms. Pipe sold separately.	Aluminum	

# ACCESSORIES

Part #	Description	Color	Size	Notes
300100 300125	 8" Nylon Tie-Down Cleat Bulk package of 25	Black	8" 20.32cm	
300210	 10" Powder Coated Aluminum Tie-Down Cleat 10" corrosion resistant cast aluminum heavy-duty tie down cleat for use on EZ Dock, traditional wood or aluminum frame docks or ports.	Aluminum	10" 25.4cm	
301260 301260-EZGR 302060 302060-EZGR	 5' x 12" Utility Channel 5' x 20" Utility Channel Two-piece chaseway attaches to dock sections for utility lines. Stainless steel hardware option.	Beige Grey	60" x 12" 1.5m x 0.3m 60" x 20" 1.5m x 0.5m	
300600 300600FG	 Dock Slide Install with almost any EZ Dock* where water depth is more than 5' (1.52m)	Blue Forest Green	Requires use of (2) 80" (2m) dock sections 600lbs. 272.1kg	
201030 201030-EZGR	 Pocket Filler with Retainer Clip	Beige Grey	6 3/8" x 4" x 3" 16cm x 10cm x 7.6	
208110 208110-EZGR	 Supplemental Flotation Pod This float pod is designed to add 200lbs (91 kg) of flotation and is sized to fit under most dock pylon shapes.	Beige Grey	27lbs. 12.2kg 41lbs. 18.6kg	
900050	 Dock Wheels - Steel frames with polyethylene wheels make movement of docks easier. Sold in pairs.	Black	85lbs. per pair 38.5kg	
201040SS	 Hardware Connector Male For attaching various accessories. 5/8" SS bolt and nut.	Black		
S21141SS S21142SS 201041SS	 Hardware Connector Female For Ladder with 3/8" SS bolt and nut. 5/8" SS bolt and nut.	Black		

Part #	Description	Color	Size	Notes
300760 300760-EZGR	 <p>Corner Storage Box w/Gusset Available in connection boxes for complete utility hookups.</p>	Beige Grey	65lbs. 29.48kg	
300750 300750-EZGR	 <p>Storage Box Permanently mounted</p>	Beige Grey	63lbs. 28.57kg	
300501 300501-EZGR	 <p>Corner Gusset Polyethylene corner gusset adds deck surface and additional stability to dock fingers when needed.</p>	Beige Grey	33.5" x 6" 85cm x 15.24cm	
300260 300260-EZGR	 <p>Swim Ladder One-piece polyethylene ladder. No exposed hardware.</p>	Beige Grey	400lb. (181.4kg) weight capacity	
300180 300180-EZGR	 <p>Dock Bumper Protects boat gunwales and rub-rails. Dock bumper attaches to dock using embedded T-nuts.</p>	Beige Grey		
300970AL 300970AL-EZGR	 <p>Poly Bench with Arm-Rests Redesigned brackets with 2" (5cm) square, .25" (0.63cm) aluminum tubing. Installs along any open 3-pocket span on an EZ Dock product.</p>	Beige Grey	116lbs. 52.5kg	
300965AL 300965AL-EZGR	 <p>Poly Bench without Arm-Rests Redesigned brackets with 2" (5cm) square, .25" (0.63cm) aluminum tubing. Installs along any open 3-pocket span on an EZ Dock product.</p>	Beige Grey	80lbs. 36.2kg	
9000010ss	 <p>In-Water Installation Tool In-water connection tool for dock sections. Stainless Steel.</p>	Stainless Steel	45" X 12" X 1" 114cm x 30.4cm x 2.54cm	
900005	 <p>Socket Adapter Tool Socket tool for connection hardware.</p>	Black		

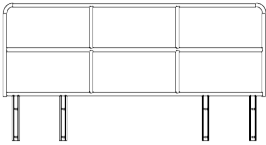
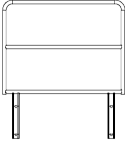
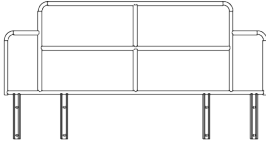
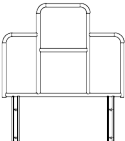
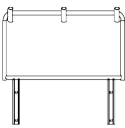
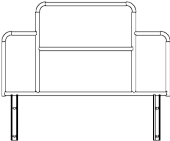
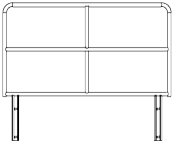
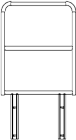
# RAILINGS

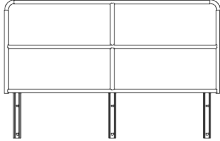
Part #/Style #	Description	Color	Size	Notes
100910AL Style 910	 For commercial or residential use. SOBA/ADA compliant. Hardware included.	Aluminum	10' x 42" 3m x 1.1m	
100911AL Style 911	 For commercial or residential use. SOBA/ADA compliant. Hardware included.	Aluminum	5' x 42" 1.5m x 1.1m	
100912AL Style 912	 For commercial or residential use. SOBA/ADA compliant. Hardware included.	Aluminum	10' x 42" 3m x 1.1m	
100915AL Style 915	 For commercial or residential use. SOBA/ADA compliant. Hardware included.	Aluminum	5' x 42" 1.5m x 1.1m	
100916AL Style 916	 For commercial or residential use. SOBA/ADA compliant. Hardware included.	Aluminum	5' x 42" 1.5m x 1.1m	
100917AL Style 917	 For commercial or residential use. SOBA/ADA compliant. Hardware included.	Aluminum	80" x 42" 2m x 1.1m	
100918AL Style 918	 For commercial or residential use. SOBA/ADA compliant. Hardware included.	Aluminum	80" x 42" 2m x 1.1m	
100919AL Style 919	 For commercial or residential use. SOBA/ADA compliant. Hardware included.	Aluminum	40" x 42" 1m x 1.1m	
100920AL Style 920	 For commercial or residential use. SOBA/ADA compliant. Hardware included.	Aluminum	40" x 42" 1m x 1.1m	
100921AL Style 921	 For commercial or residential use. SOBA/ADA compliant. Hardware included.	Aluminum	100" x 42" 2.5m x 1.1m	

Part #/Style #	Description	Color	Size	Notes
100900 100900-EZGR 	<b>Poly Post Handrails</b> Attaches to the coupler pocket. Can be used as a grab or accessory attachment post. 8 embedded T-nuts for cleat attachment and recessed holes that can be drilled for tube or rope handrails. (Handrails and Cleats not included.)	Beige Grey		

## POLY POST HANDRAILS



## ALUMINUM RAILING



# GANGWAYS ALUMINUM

EZ Dock is pleased to announce the availability of our new G500 series gangways hinge kits and dock to shore transition ramps. All G500 gangway frames are made of lightweight aluminum materials that are carefully welded in the USA by skilled welders. G500 gangways weigh 25% less (approx.) than G400 series gangways. ADA compliant railings can be assembled at the job site (Mounting hardware is provided.)

Available in popular 36" (0.9m) and 48" (1.2m) widths and lengths ranging from 10' (3m) to 30' (9.1m) in 5' increments, the new gangways come with the buyer's choice of factory installed beige or grey ThruFlow decking to create a consistent look with other EZ Dock products.

ThruFlow panels are durable and maintenance free allowing you to spend more time enjoying your deck or dock, than working on it. They also feature a heat-resistant, non-slip surface for safety and comfort. This decking is covered by ThruFlow's Lifetime Limited Warranty. ThruFlow panels are revolutionary in their ability to allow light to pass through protecting the delicate aquatic life below. They also allow wind and water to safely pass through them, helping to prevent damage that may be incurred by high waves and wind.

Slip resistant aluminum decking with heat sink bottoms to draw heat away from the decking surface is also available as a decking option.

All decking panels are installed at the factory to provide a clean, flush appearance. All new decking must be installed to meet local, state, and federal building codes or other regulations that apply to these products at the installer's discretion and responsibility.

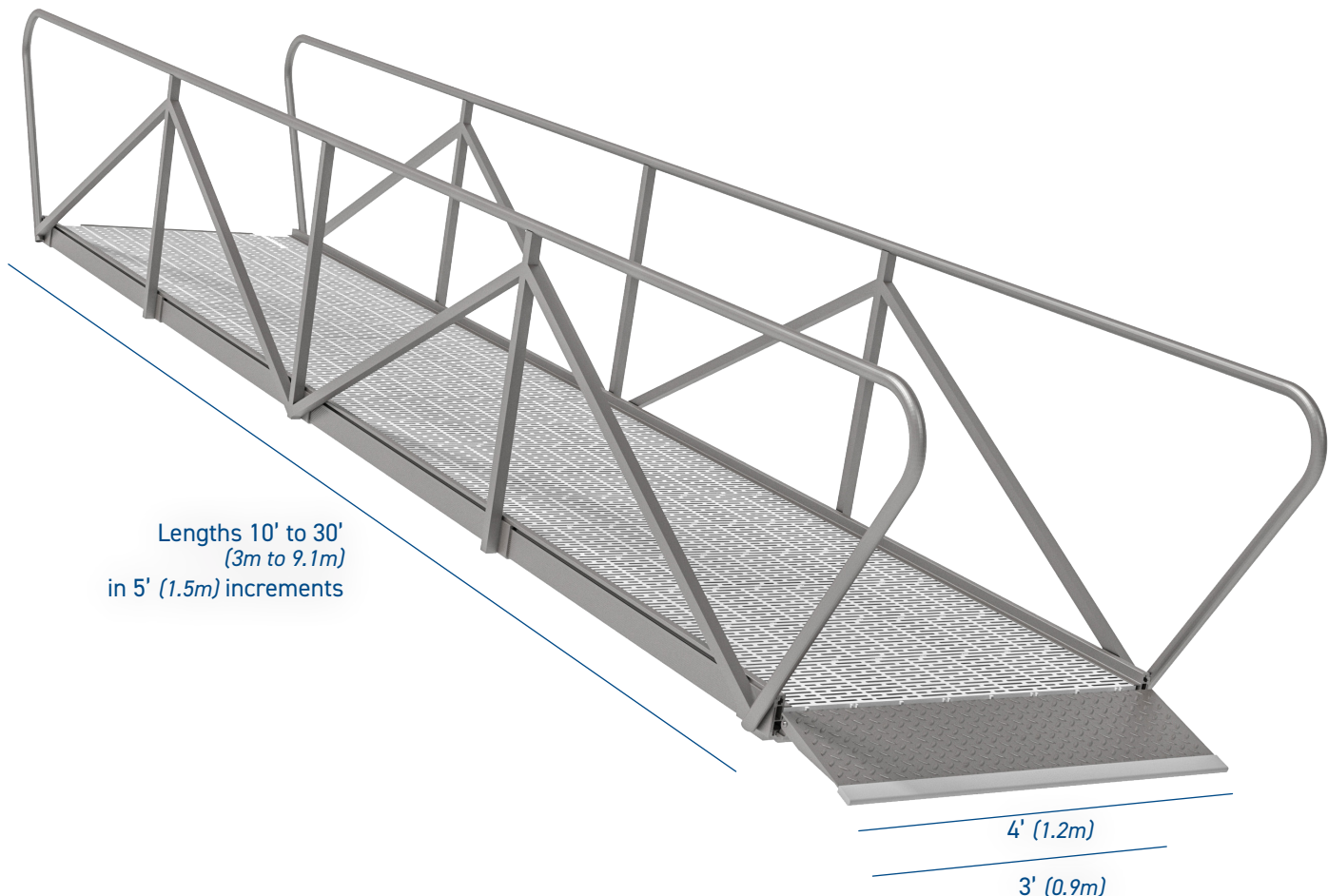

Part #/Style #	Description	Color	Size	Notes
G500310 G500310-EZGR	Aluminum Gangway and Railings with ThruFlow Decking	Railings - Aluminum	3' x 10' 0.9m x 3m	
G500315 G500315-EZGR		ThruFlow Decking - Beige or Grey	3' x 15' 0.9m x 4.5m	
G500320 G500320-EZGR			3' x 20' 0.9m x 6m	
G500325 G500325-EZGR			3' x 25' 0.9m x 7.6m	
G500330 G500330-EZGR			3' x 30' 0.9m x 9.1m	
G500410 G500410-EZGR			4' x 10' 1.2m x 3m	
G500415 G500415-EZGR			4' x 15' 1.2m x 4.5m	
G500420 G500420-EZGR			4' x 20' 1.2m x 6m	
G500425 G500425-EZGR			4' x 25' 1.2m x 7.6m	
G500430 G500430-EZGR			4' x 30' 1.2m x 9.1m	
G500310AL		Aluminum Gangway and Railings with Aluminum Decking	Railings - Aluminum	3' x 10' 0.9m x 3m
G500315AL	Decking - Aluminum		3' x 15' 0.9m x 4.5m	
G500320AL			3' x 20' 0.9m x 6m	
G500325AL			3' x 25' 0.9m x 7.6m	
G500330AL			3' x 30' 0.9m x 9.1m	
G500410AL			4' x 10' 1.2m x 3m	
G500415AL			4' x 15' 1.2m x 4.5m	
G500420AL			4' x 20' 1.2m x 6m	
G500425AL			4' x 25' 1.2m x 7.6m	
G500430AL			4' x 30' 1.2m x 9.1m	

# GANGWAY ACCESSORIES

Part #	Description	Color	Size	Notes
404010 404010-EZGR 	Polyethylene Gangway  Molded Plastic Gangway. US Pat. 6912966 (Railing and Roller Kit sold separately.)	Beige Grey	39" x 120" x 8" 1m x 3m x .2m  165lbs. 74.8kg	
300450 	Gangway Roller Kit  Allows end of gangway to adjust to changing water levels. PVC and galvanized steel roller available for 3' and 5' widths.		5' x 42" 1.5m x 1.1m	
G200360 G200560 	Gangway Hinge Hinge kit		40" (1m) dock  80" (2m) dock	
200205 200205-EZGR	Plank Gangway Kit - Dock to Abutment	Beige Grey	54" 137.16m	
200200 200200-EZGR 	Plank Gangway Kit - Dock to Shore	Beige Grey	54" 137.16m	
100240 100340 100600 	Gangway Hardware Kit for Wood Gangway	Stainless Steel Galvanized	24"  34"  60"	

Part #	Description	Color	Size	Notes
400440 400460 400480	Galvanized Gangway to Dock Kit  Kit will include all hardware to attach gangway centered on 3 or 4 pockets.	Stainless Steel Galvanized	40" (1m) dock 60" (1.5m) dock 80" (2m) dock	
400450	Galvanized Hinge Kit to Abutment  	Stainless Steel Galvanized	15" x ?" 38.1cm x ?m 30" x ?" 76.2m x ?m	
G500450 G500450-EZGR	Aluminum and ThruFlow Transition Plate Dock End	Beige Grey	48" 1.2m	
G500460 G500560	36" (0.9m) Gangway Hinge	Aluminum	60" (1.5m) dock 80" (2m) dock	
G500465	Gangway Abutment Hinge Kit	Aluminum	36" (0.9m) 48" (1.2m)	
G500570 G500570-EZGR	Aluminum Transition Ramp with ThruFlow	Beige Grey	48" x 72" 1.2m x 1.82m	
G500570-AL	Aluminum Transition Ramp with Aluminum decking	Aluminum	48" x 72" 1.2m x 1.82m	



EZ Dock product is produced in our Monett, MO facility which is certified by Intertek for ISO 9001:2015 quality management system and ISO 14001: 2015 environmental management system.

EZ Dock may introduce new colors, products, accessories, and options throughout the year. Specifications and products listed are subject to change without notice. Some products may be shown with additional or optional equipment not available through EZ Dock. Specifications may vary for international shipments. Please check with your local dealer for more information.

EZ Dock, Inc | 878 HWY 60, Monett, MO 65708

417-235-2223 | 800-654-8168

© 2023 EZ Dock, Inc. All rights reserved.

*More information*



US/Canada  
Europe  
International

1-800-654-8168  
+46 (0) 380 47 300  
+1 888-654-8168



Proudly American made for 30 years.